

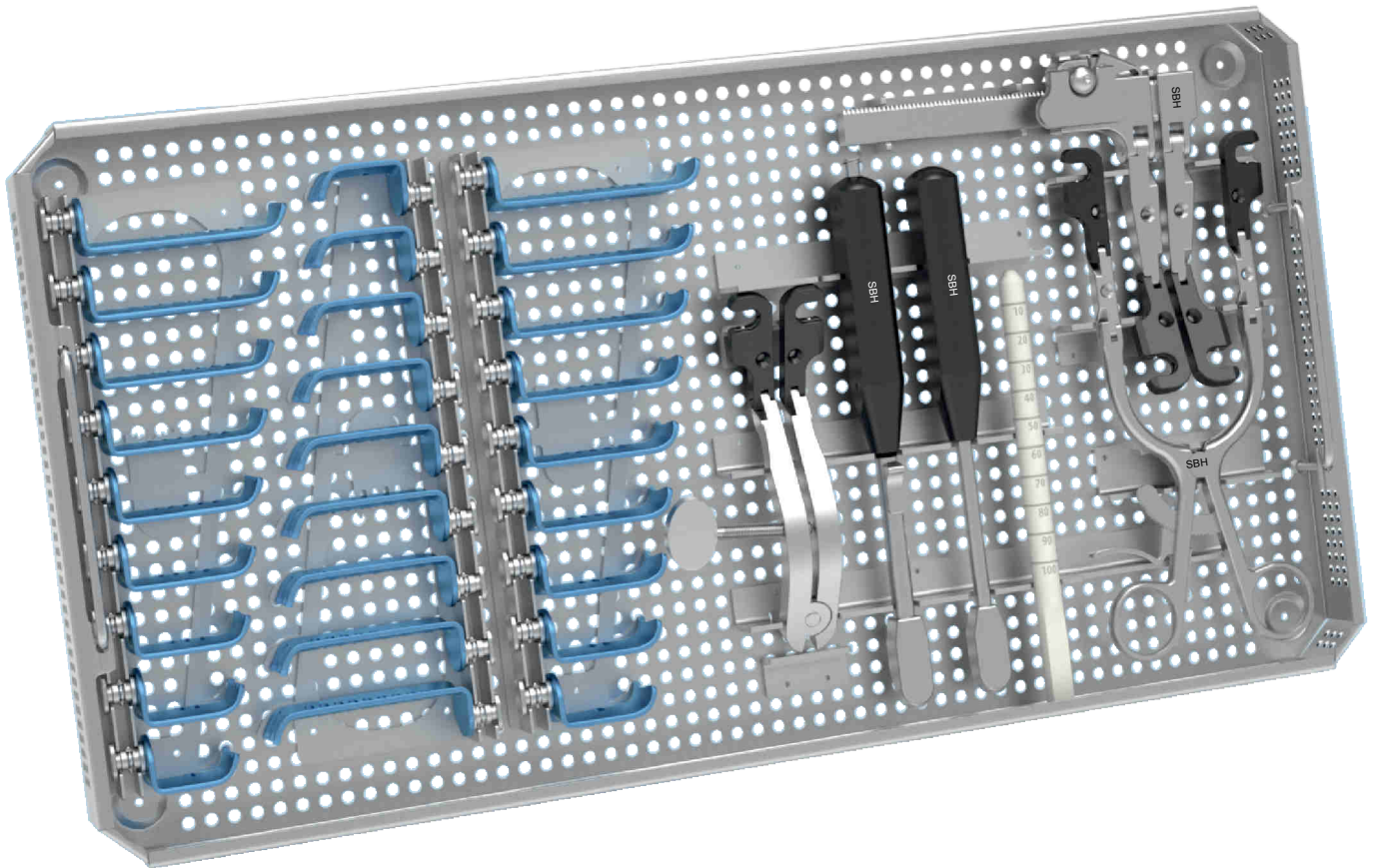

Strategic Business Holdings, Inc.

...Quality Products, Superior Customer Service, & Support



- Cervical retraction system
- Titanium color-coded, radiolucent
- Side load for optimal exposure
- Large variety of blades

RADIOLUCENT

100% made in Germany

CCR Retractor System



CCR Retractor System

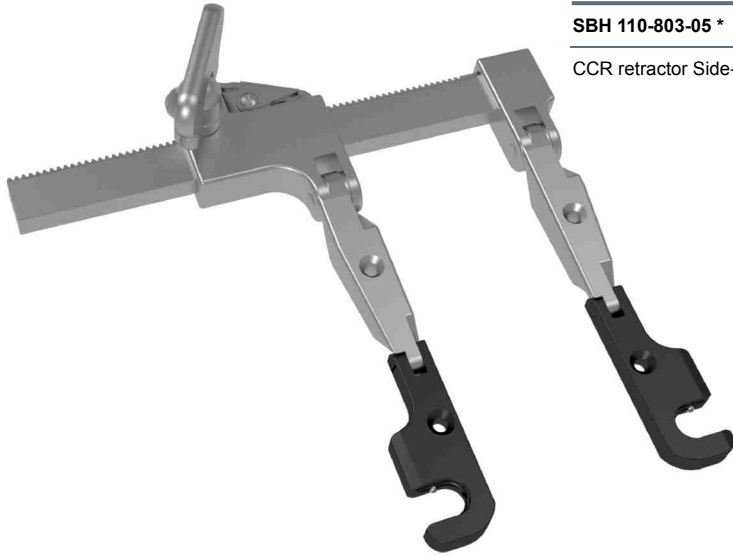
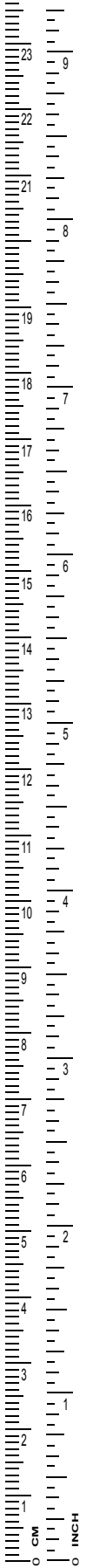

SBH 110-803-05 *

CCR retractor Side-Load, double hinge, distal hinge out of titanium



SBH 110-803-10E *

CCR counter retractor Side-load, distal hinge out of titanium



SBH 110-803-15 *

CCR basic counter retractor, double hinge, distal hinge out of titanium

CCR Retractor System



SBH 110-804-00 *

CCR/CLR handle for blades with black PPSU-handle



SBH 110-804-05 *

CCR/CLR handle for blades, cannulated with Luer-Lock, with black PPSU-handle



SBH 110-794-10 *

CCR/CLR depth gauge instrument, natural



All blades out of Titanium, radiolucent, with side-load-mechanism

	B - width
green	19 mm
blue	24 mm

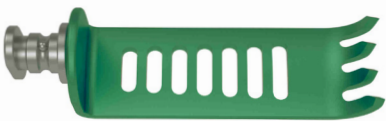

CCR-blade green with 4 teeth

	B - width	T - depth
SBH 110-805-05	19 mm	25 mm
SBH 110-805-10	19 mm	30 mm
SBH 110-805-15	19 mm	35 mm
SBH 110-805-20	19 mm	40 mm
SBH 110-805-25	19 mm	45 mm
SBH 110-805-30	19 mm	50 mm
SBH 110-805-35	19 mm	55 mm
SBH 110-805-40	19 mm	60 mm
SBH 110-805-45	19 mm	65 mm
SBH 110-805-50	19 mm	70 mm
SBH 110-805-55	19 mm	75 mm



CCR blade blunt longitudinal

	B - width	T - depth
SBH 110-806-05	19 mm	25 mm
SBH 110-806-10	19 mm	30 mm
SBH 110-806-15	19 mm	35 mm
SBH 110-806-20	19 mm	40 mm
SBH 110-806-25	19 mm	45 mm
SBH 110-806-30	19 mm	50 mm
SBH 110-806-35	19 mm	55 mm
SBH 110-806-40	19 mm	60 mm
SBH 110-806-45	19 mm	65 mm
SBH 110-806-50	19 mm	70 mm
SBH 110-806-55	19 mm	75 mm

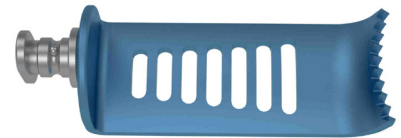

CCR - Valve, 8-teeth lateral

	B - width	T - depth
SBH 110-807-05	19 mm	25 mm
SBH 110-807-10	19 mm	30 mm
SBH 110-807-15	19 mm	35 mm
SBH 110-807-20	19 mm	40 mm
SBH 110-807-25	19 mm	45 mm
SBH 110-807-30	19 mm	50 mm
SBH 110-807-35	19 mm	55 mm
SBH 110-807-40	19 mm	60 mm
SBH 110-807-45	19 mm	65 mm
SBH 110-807-50	19 mm	70 mm
SBH 110-807-55	19 mm	75 mm

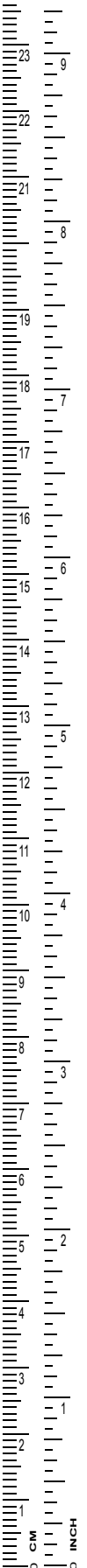



CCR Retractor System

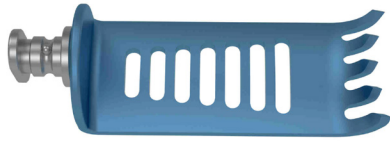

CCR Valve, 5 teeth, medial

	B - width	T - depth
SBH 110-808-05	24 mm	25 mm
SBH 110-808-10*	24 mm	30 mm
SBH 110-808-15*	24 mm	35 mm
SBH 110-808-20*	24 mm	40 mm
SBH 110-808-25*	24 mm	45 mm
SBH 110-808-30*	24 mm	50 mm
SBH 110-808-35*	24 mm	55 mm
SBH 110-808-40*	24 mm	60 mm
SBH 110-808-45*	24 mm	65 mm
SBH 110-808-50*	24 mm	70 mm
SBH 110-808-55	24 mm	75 mm

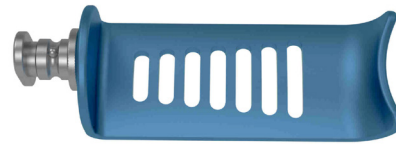

CCR Valve, blunt longitudinal

	B - width	T - depth
SBH 110-809-05	24 mm	25 mm
SBH 110-809-10	24 mm	30 mm
SBH 110-809-15*	24 mm	35 mm
SBH 110-809-20*	24 mm	40 mm
SBH 110-809-25*	24 mm	45 mm
SBH 110-809-30*	24 mm	50 mm
SBH 110-809-35*	24 mm	55 mm
SBH 110-809-40*	24 mm	60 mm
SBH 110-809-45*	24 mm	65 mm
SBH 110-809-50*	24 mm	70 mm
SBH 110-809-55*	24 mm	75 mm

SBH 120-968-64 *

CCR-Tray, stainless steel with lid / dimensions: 485 mm x 253 mm x 30 mm



SBH 110-803-20

CCR-Set consisting of products marked (one piece each)

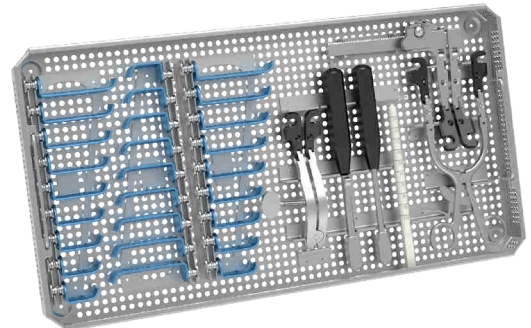

Changes in technical specifications and dimensions are at our discretion. Subject to modification. Without our explicit written approval this print media may not be copied or reprinted as a whole or in extracts.



Strategic Business Holdings, Inc.

...Quality Products, Superior Customer Service, & Support

Main +1 (800) 303-3050 Fax +1 (949) 600-8874 9620 Research Drive, Irvine, CA 92618 USA info@sbhsurgical.com www.sbhsurgical.com

Copyright © SBH ©. 2020 - All rights reserved.