



Strategic Business Holdings, Inc.

...Quality Products, Superior Customer Service, & Support





100% made in Germany

Laminectomy Punches and Rongeurs
Pinzas cortantes para Laminectomía

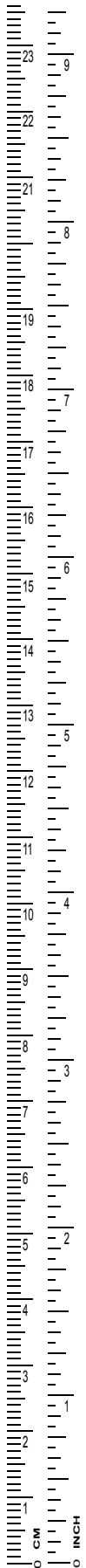

Laminectomy Punches - Pinzas cortantes para Laminectomía



	2,0 mm	SB 111-500-02
	3,0 mm	SB 111-500-03





CITELLI



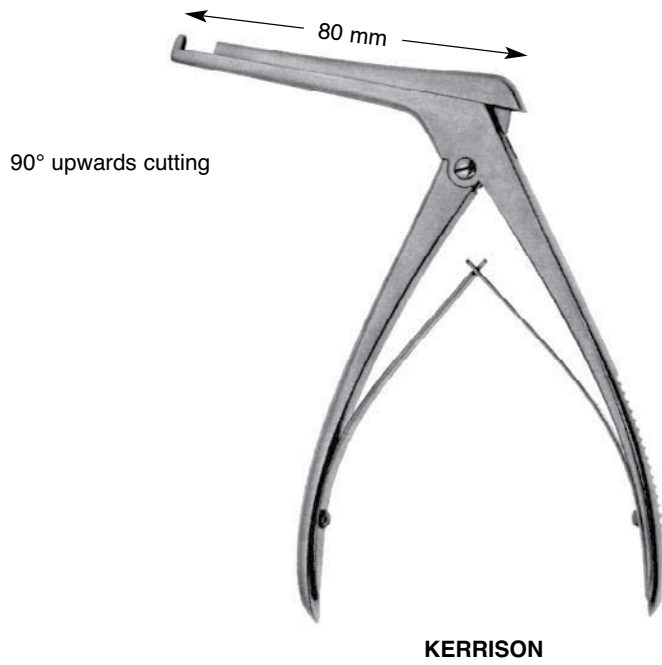



	2,0 mm	SB 111-502-19
---	--------	----------------------

BEYER

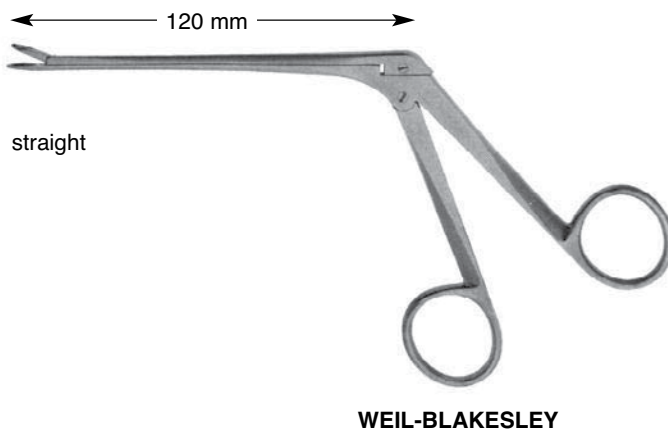

	3,0 mm	SB 111-506-03
	4,0 mm	SB 111-506-04
	5,0 mm	SB 111-506-05
	6,0 mm	SB 111-506-06



	2,5 x 5,0 mm	SB 113-200-01
	3,6 x 8,0 mm	SB 113-200-02
	4,8 x 12,0 mm	SB 113-200-03

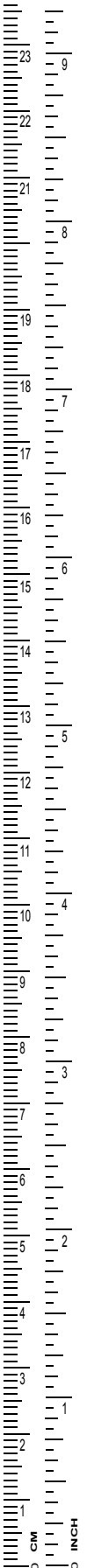



Laminectomy Punches - Pinzas cortantes para Laminectomía

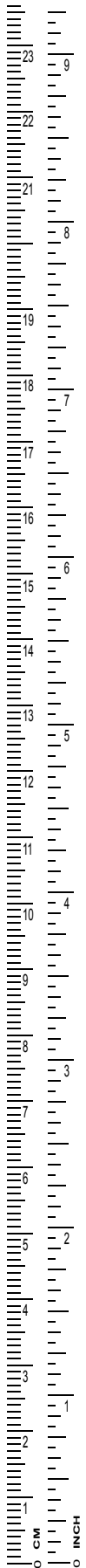

110 mm



curved on flat

	2,5 x 5,0 mm	SB 113-201-01
	3,6 x 8,0 mm	SB 113-201-02
	4,8 x 12 mm	SB 113-201-04

WEIL-BLAKESLEY

120 mm



straight
recta

	3,0 x 10,0 mm	SB 113-120-40
--	---------------	----------------------

TAKAHASHI

115 mm





curved on flat

	3,0 x 10,0 mm	SB 113-121-40
--	---------------	----------------------

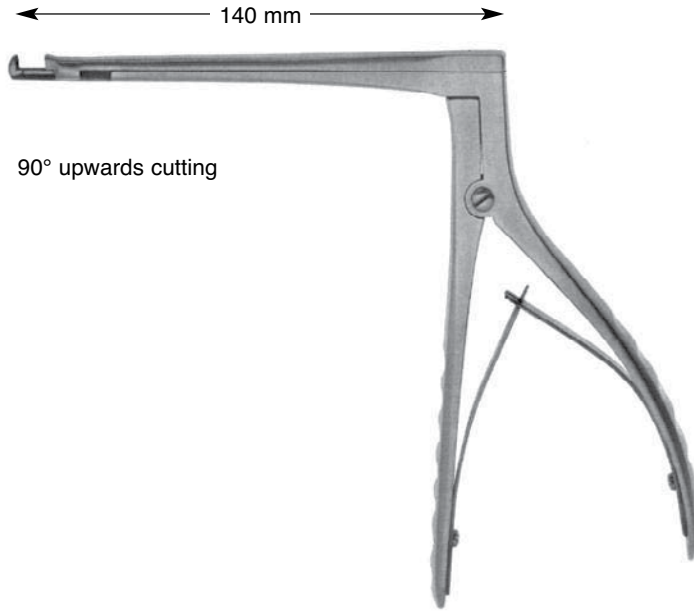
TAKAHASHI



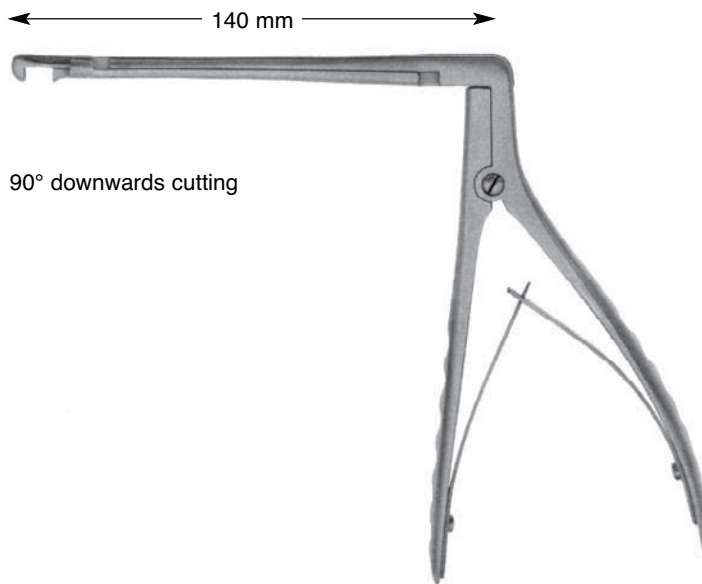

HAJEK-KOFLER

	3,5 mm	SB 113-172-14
	4,6 mm	SB 113-170-14



HAJEK-KOFLER

	3,5 mm	SB 113-173-14
	4,6 mm	SB 113-171-14

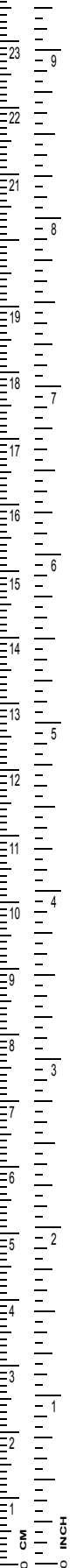



Laminectomy Punches - *Pinzas cortantes para Laminectomía*

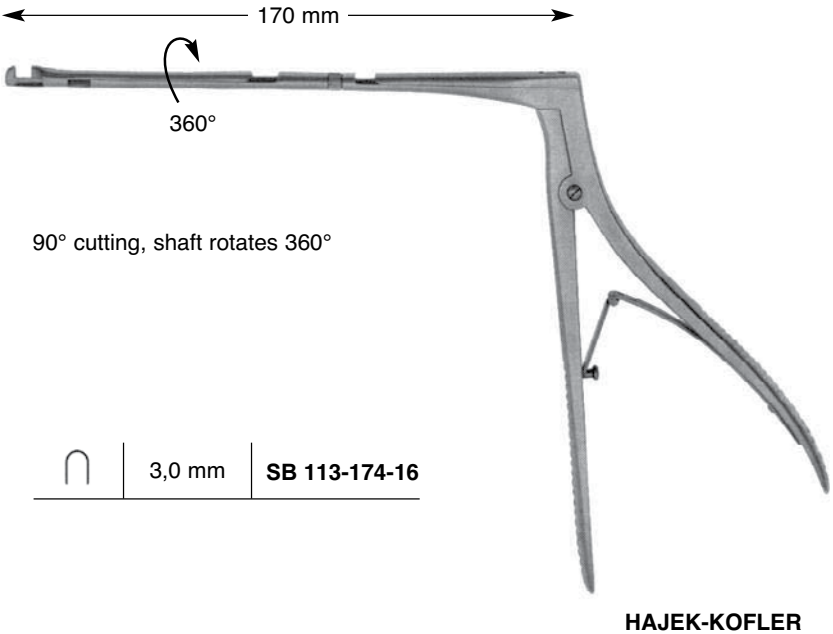
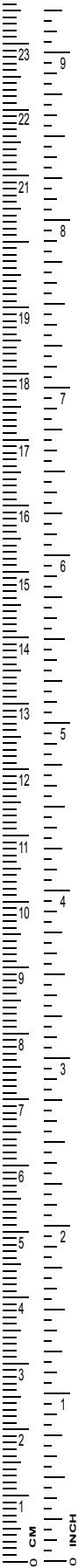

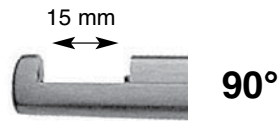

LOVE-KERRISON

Width of bite Anchura de la boca	Length of shaft	
	180 mm	200 mm
2 mm	SB 240-001-02	SB 240-002-02
3 mm	SB 240-001-03	SB 240-002-03
4 mm	SB 240-001-04	SB 240-002-04
5 mm	SB 240-001-05	SB 240-002-05
6 mm	2SB 40-001-06	SB 240-002-06

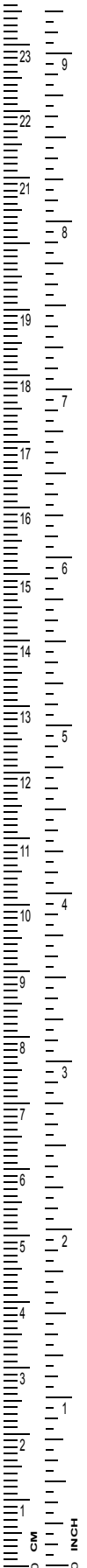



Laminectomy Punches - *Pinzas cortantes para Laminectomía*

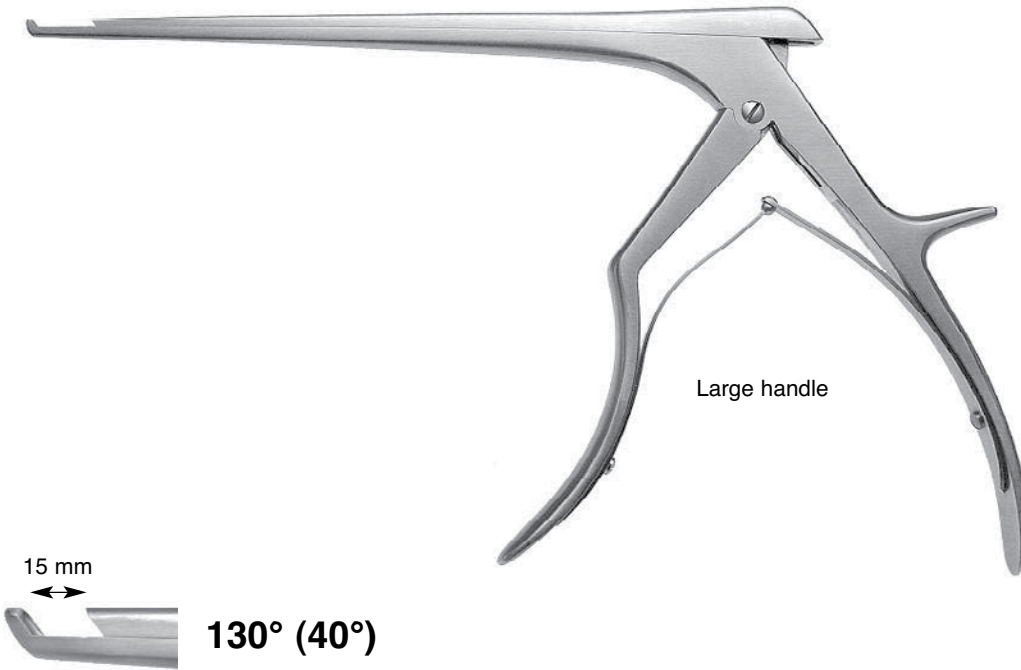

LOVE-KERRISON

Width of bite	Length of shaft		
	180 mm	200 mm	230 mm
2 mm	SB 240-021-02	SB 240-022-02	SB 240-023-02
3 mm	SB 240-021-03	SB 240-022-03	SB 240-023-03
4 mm	SB 240-021-04	SB 240-022-04	SB 240-023-04
5 mm	SB 240-021-05	SB 240-022-05	SB 240-023-05
6 mm	SB 240-021-06	SB 240-022-06	SB 240-023-06

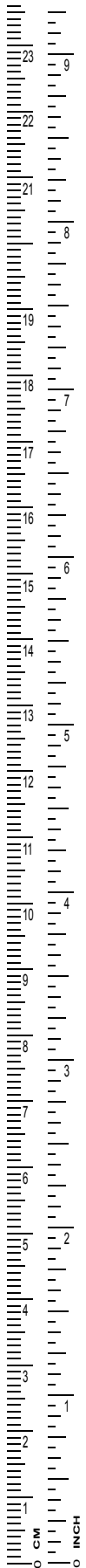

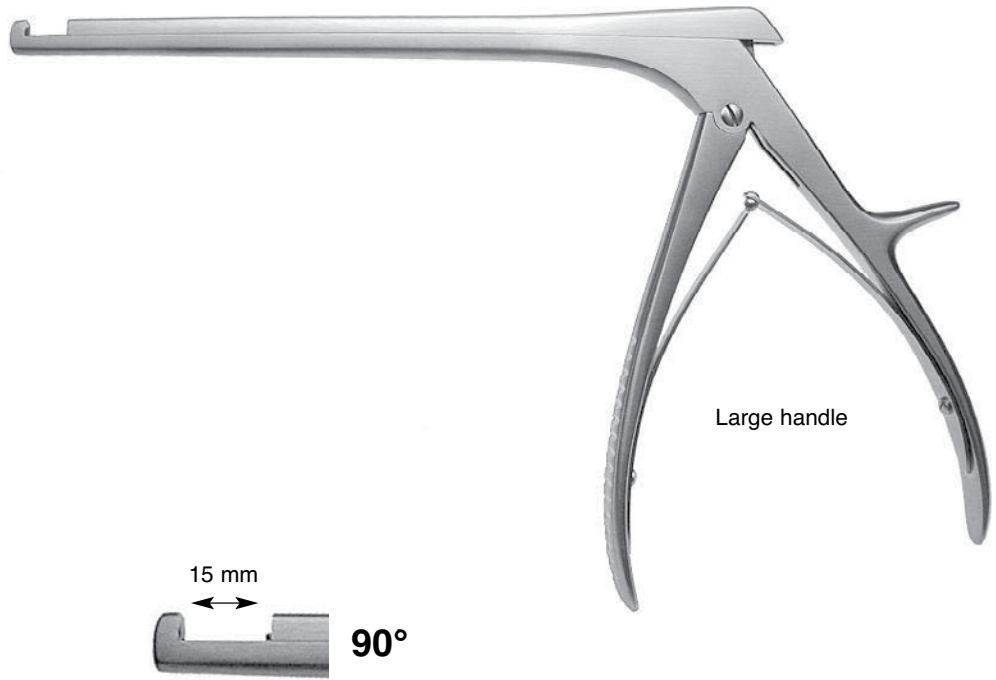

LOVE-KERRISON

Width of bite	Length of shaft	
	180 mm	200 mm
2 mm	SB 240-121-02	SB 240-122-02
3 mm	SB 240-121-03	SB 240-122-03
4 mm	SB 240-121-04	SB 240-122-04
5 mm	SB 240-121-05	SB 240-122-05
6 mm	SB 240-121-06	SB 240-122-06

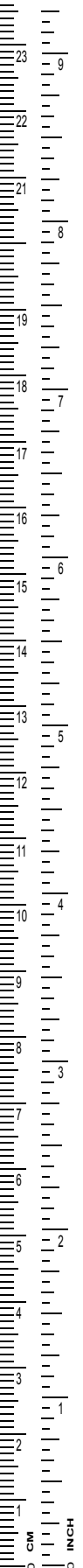



Laminectomy Punches - *Pinzas cortantes para Laminectomía*

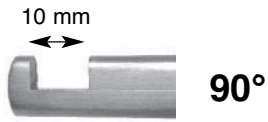
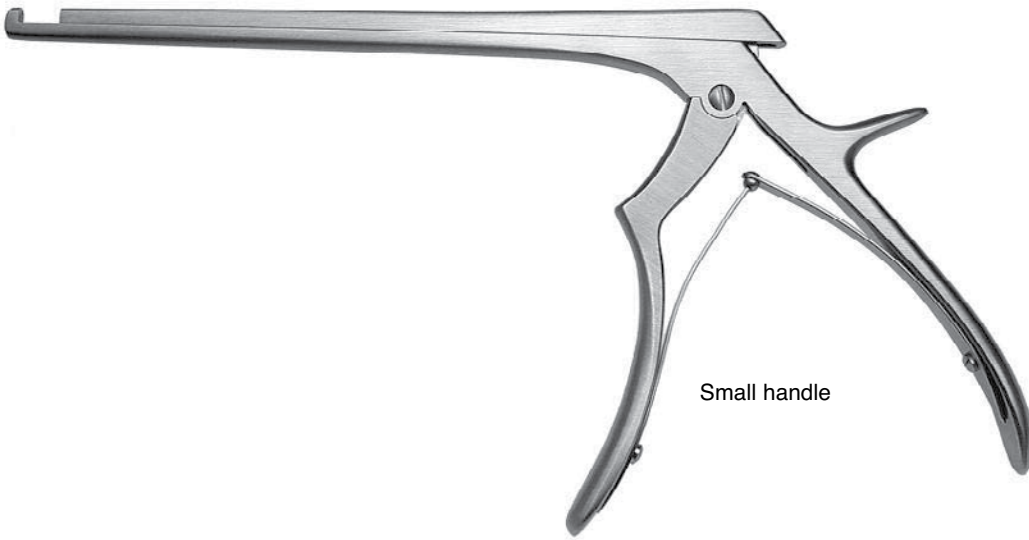

KERRISON

Width of bite	Length of shaft		
	180 mm	200 mm	230 mm
1 mm	SB 240-051-01	SB 240-052-01	-
2 mm	SB 240-051-02	SB 240-052-02	SB 240-053-02
3 mm	SB 240-051-03	SB 240-052-03	SB 240-053-03
4 mm	SB 240-051-04	SB 240-052-04	SB 240-053-04
5 mm	SB 240-051-05	SB 240-052-05	SB 240-053-05
6 mm	SB 240-051-06	SB 240-052-06	-

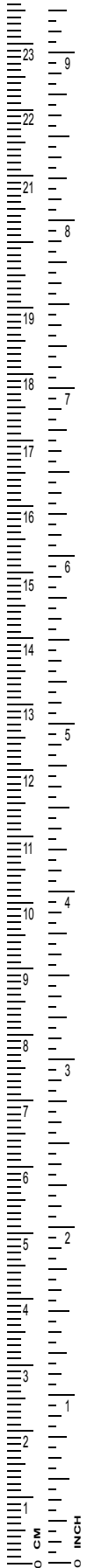

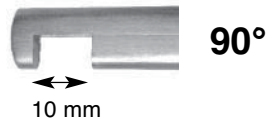
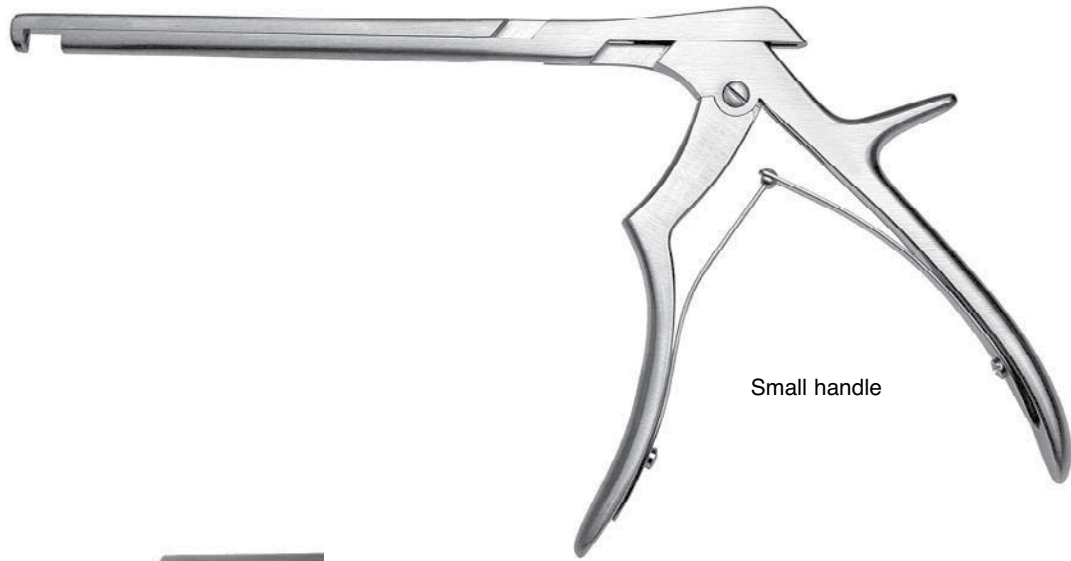

KERRISON

Width of bite Anchura de la boca	Length of shaft	
	180 mm	200 mm
2 mm	SB 240-061-02	SB 240-062-02
3 mm	SB 240-061-03	SB 240-062-03
4 mm	SB 240-061-04	SB 240-062-04
5 mm	SB 240-061-05	SB 240-062-05
6 mm	SB 240-061-06	SB 240-062-06

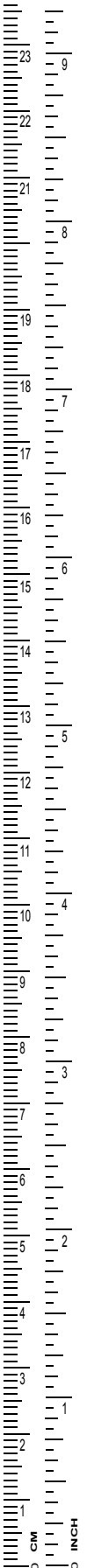



Laminectomy Punches - Pinzas cortantes para Laminectomía

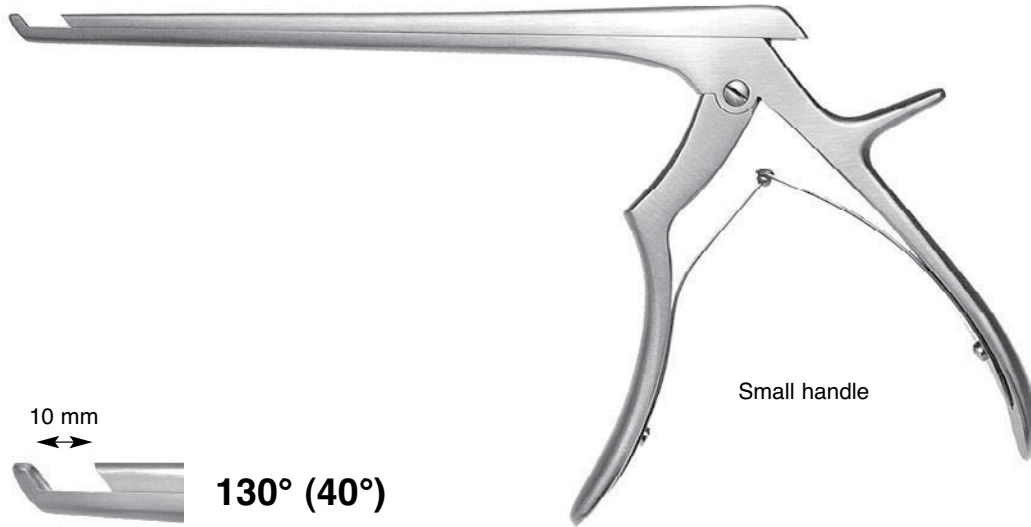

KERRISON

Width of bite	Length of shaft		
	180 mm	200 mm	230 mm
1 mm	SB 240-071-01	SB 240-072-01	–
2 mm	SB 240-071-02	SB 240-072-02	SB 240-073-02
3 mm	SB 240-071-03	SB 240-072-03	SB 240-073-03
4 mm	SB 240-071-04	SB 240-072-04	SB 240-073-04
5 mm	SB 240-071-05	SB 240-072-05	SB 240-073-05
6 mm	2SB 40-071-06	SB 240-072-06	–

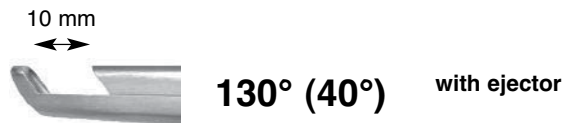

KERRISON

Width of bite	Length of shaft	
	180 mm	200 mm
2 mm	SB 240-071-02A	SB 240-072-02A
3 mm	SB 240-071-03A	SB 240-072-03A
4 mm	SB 240-071-04A	SB 240-072-04A
5 mm	SB 240-071-05A	SB 240-072-05A

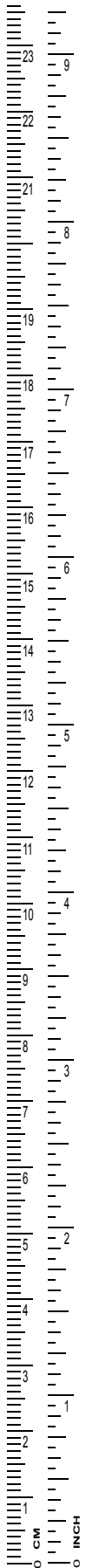

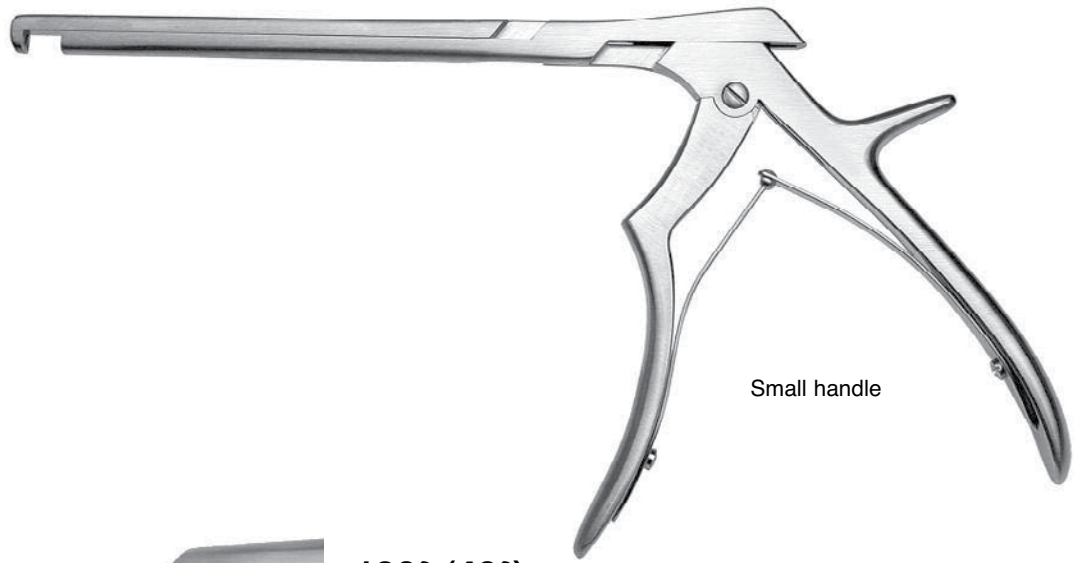

KERRISON

Width of bite	Length of shaft	
	180 mm	200 mm
2 mm	SB 240-081-02	SB 240-082-02
3 mm	SB 240-081-03	SB 240-082-03
4 mm	SB 240-081-04	SB 240-082-04
5 mm	SB 240-081-05	SB 240-082-05

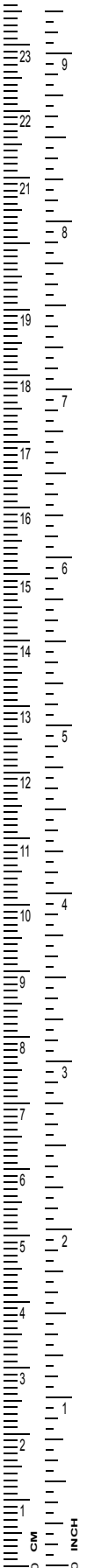



Laminectomy Punches - Pinzas cortantes para Laminectomía

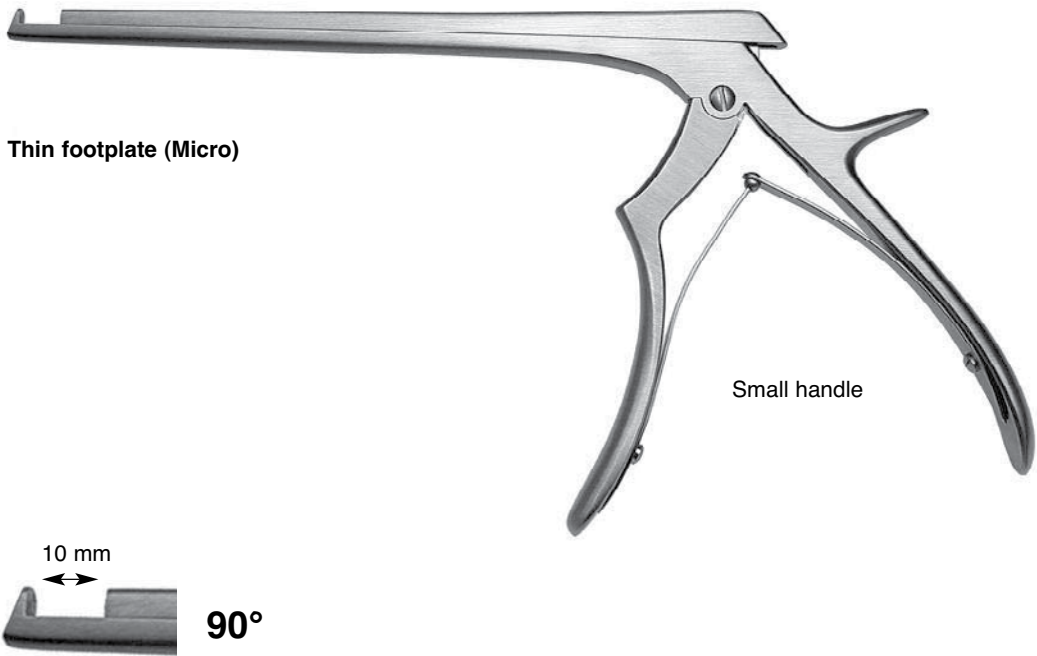
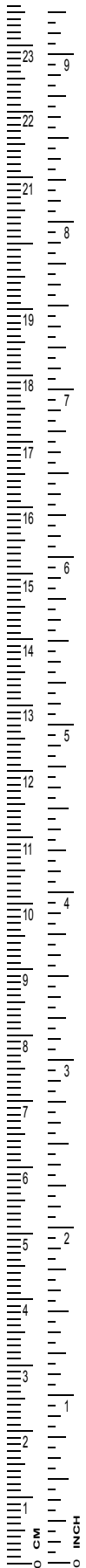

KERRISON

Width of bite	Length of shaft		
	180 mm	200 mm	230 mm
2 mm	SB 240-051-02T	SB 240-052-02T	SB 240-053-02T
3 mm	SB 240-051-03T	SB 240-052-03T	SB 240-053-03T
4 mm	SB 240-051-04T	SB 240-052-04T	SB 240-053-04T
5 mm	SB 240-051-05T	SB 240-052-05T	SB 240-053-05T
6 mm	SB 240-051-06T	SB 240-052-06T	-

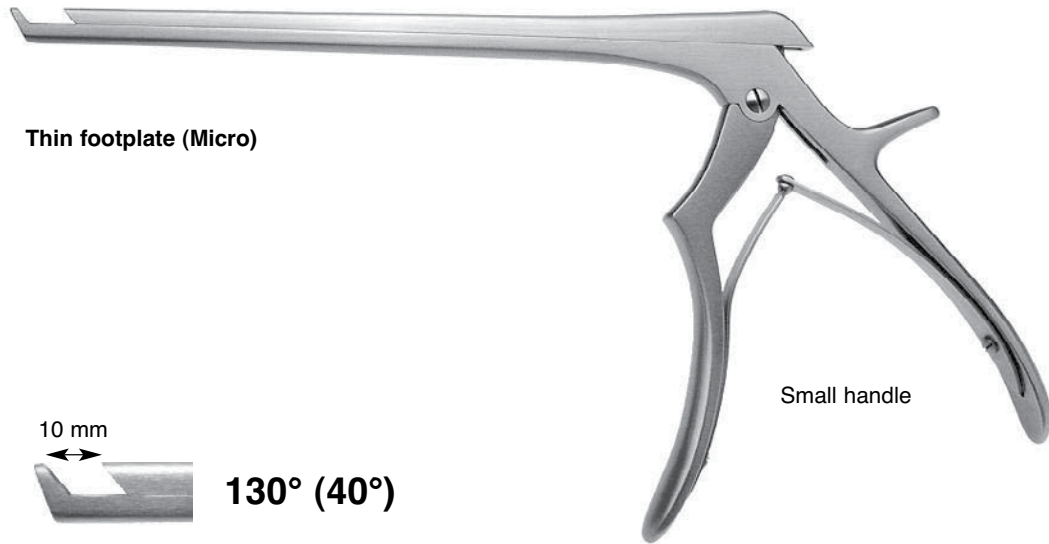

Thin footplate (Micro)

10 mm

130° (40°)

Small handle

KERRISON

Width of bite	Length of shaft		
	180 mm	200 mm	230 mm
2 mm	SB 240-071-02T	SB 240-072-02T	SB 240-073-02T
3 mm	SB 240-071-03T	SB 240-072-03T	SB 240-073-03T
4 mm	SB 240-071-04T	SB 240-072-04T	SB 240-073-04T
5 mm	SB 240-071-05T	SB 240-072-05T	SB 240-073-05T
6 mm	SB 240-071-06T	SB 240-072-06T	-

10 mm



130° (40°)

with ejector

KERRISON

Width of bite	Length of shaft	
	180 mm	200 mm
2 mm	SB 240-071-02AT	SB 240-072-02AT
3 mm	SB 240-071-03AT	SB 240-072-03AT
4 mm	SB 240-071-04AT	SB 240-072-04AT
5 mm	SB 240-071-05AT	SB 240-072-05AT

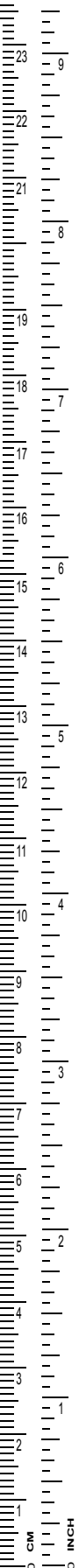



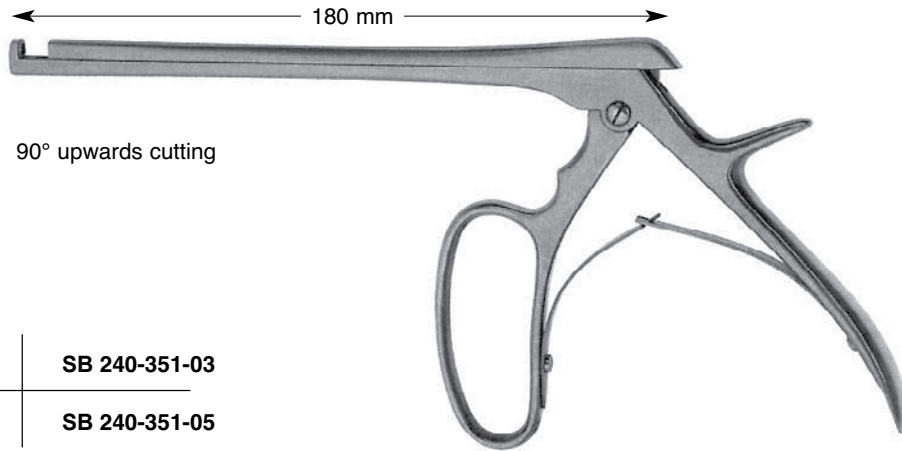
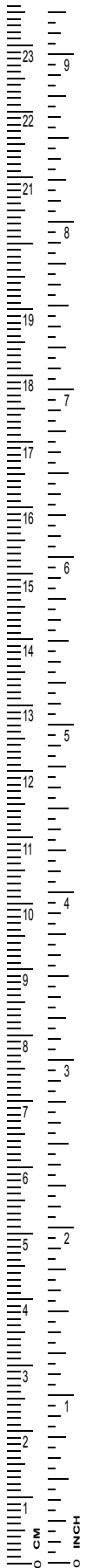

Laminectomy Punches - Pinzas cortantes para Laminectomía





90° upwards cutting

	3,0 mm	SB 240-351-03
	5,0 mm	SB 240-351-05

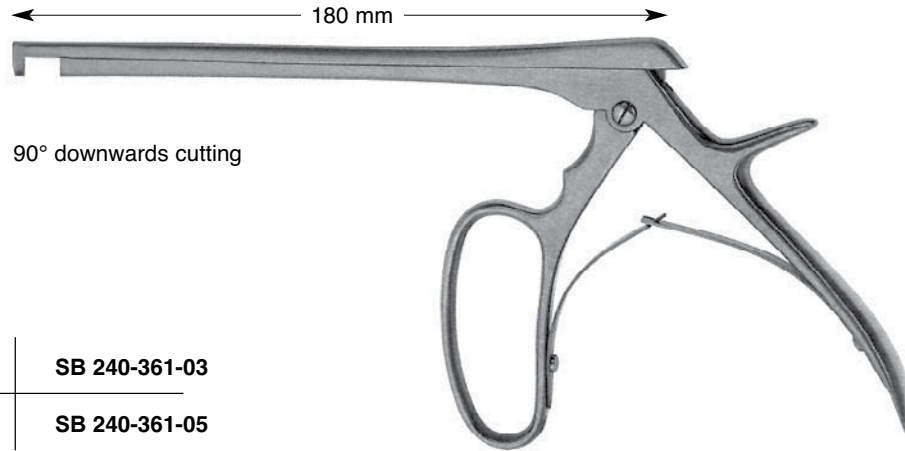
FERRIS-SMITH-KERRISON





90° downwards cutting

	3,0 mm	SB 240-361-03
	5,0 mm	SB 240-361-05

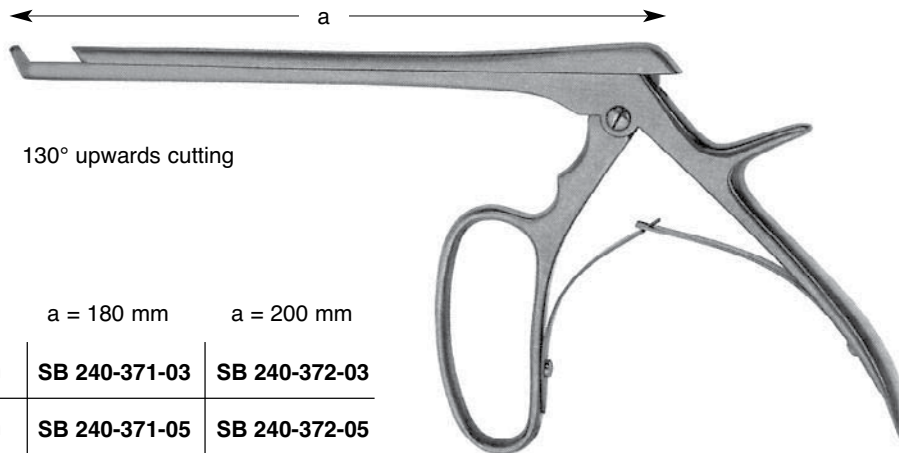
FERRIS-SMITH-KERRISON



130° upwards cutting

		a = 180 mm	a = 200 mm
	3,0 mm	SB 240-371-03	SB 240-372-03
	5,0 mm	SB 240-371-05	SB 240-372-05

FERRIS-SMITH-KERRISON

Pinzas cortantes para Laminectomía - Laminectomy Rongeurs



straight

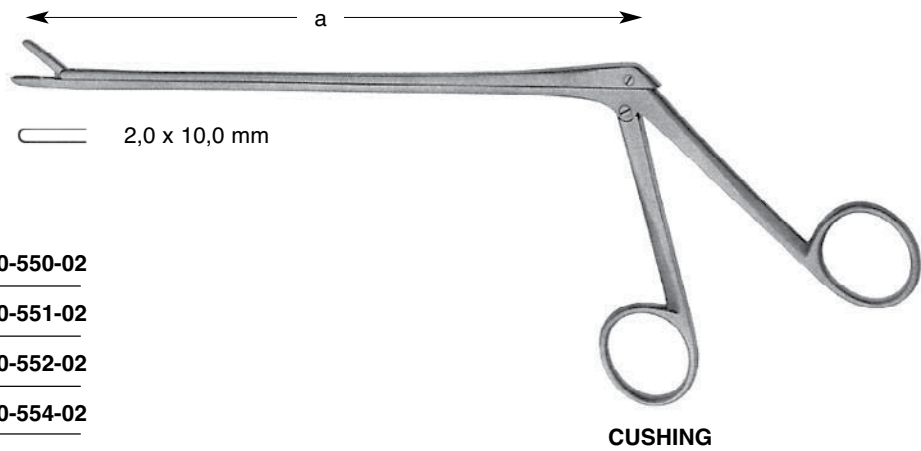

a = 130 mm	SB 240-550-02
a = 150 mm	SB 240-551-02
a = 180 mm	SB 240-552-02
a = 230 mm	SB 240-554-02
a = 280 mm	SB 240-557-02

curved on flat

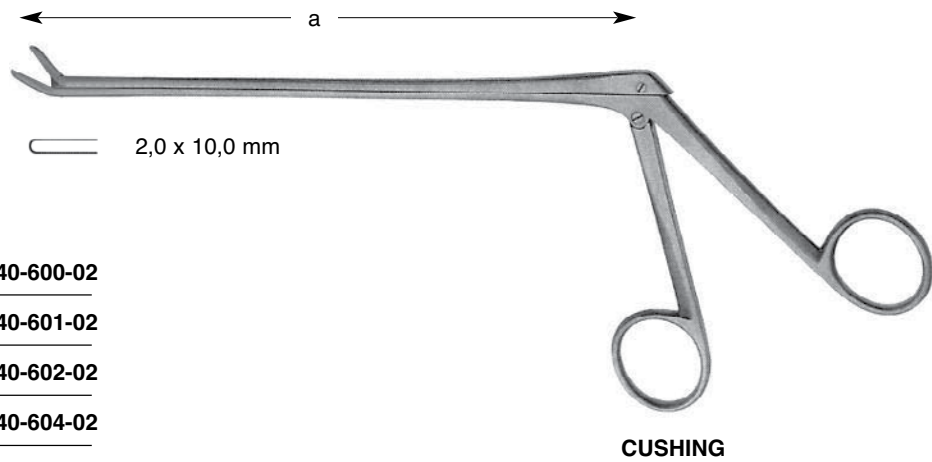

a = 130 mm	SB 240-600-02
a = 150 mm	SB 240-601-02
a = 180 mm	SB 240-602-02
a = 230 mm	SB 240-604-02
a = 280 mm	SB 240-607-02

curved down

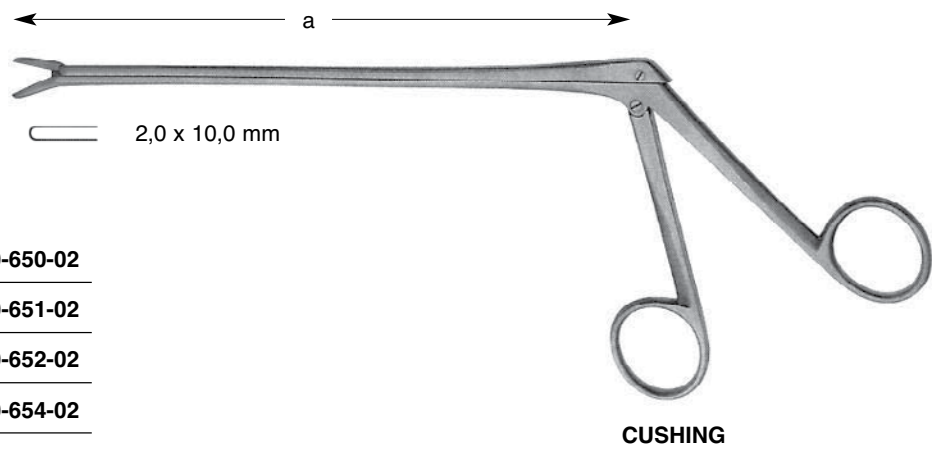

a = 130 mm	SB 240-650-02
a = 150 mm	SB 240-651-02
a = 180 mm	SB 240-652-02
a = 230 mm	SB 240-654-02
a = 280 mm	SB 240-657-02

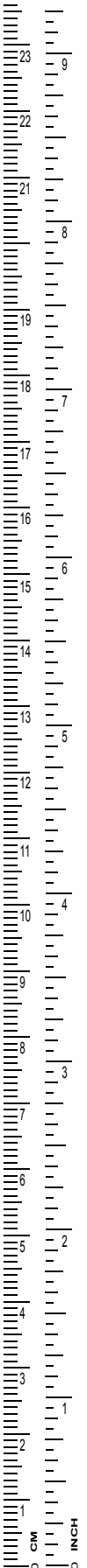



Laminectomy Rongeurs - Pinzas cortantes para Laminectomía

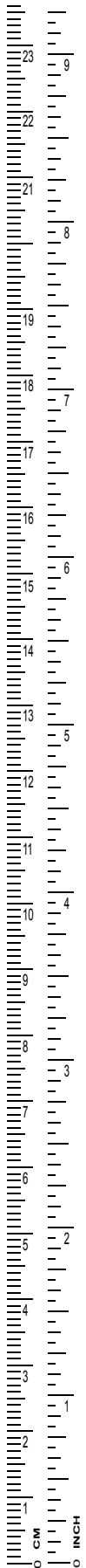

straight

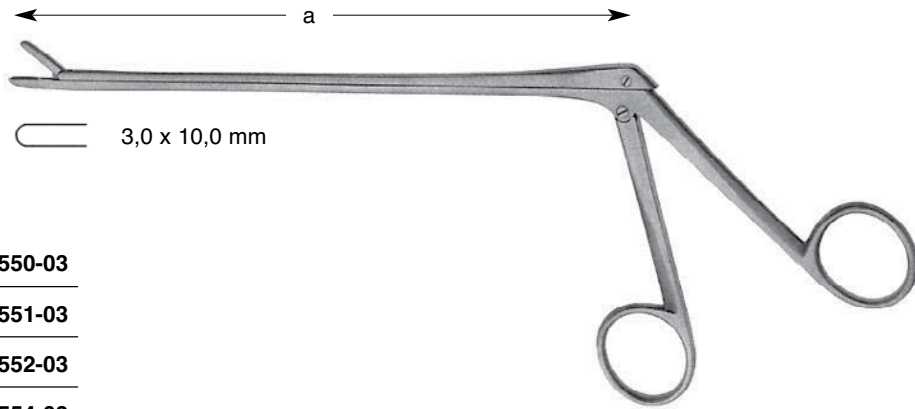

a = 130 mm	SB 240-550-03
a = 150 mm	SB 240-551-03
a = 180 mm	SB 240-552-03
a = 230 mm	SB 240-554-03
a = 280 mm	SB 240-557-03

LOVE-GRUENWALD

curved on flat

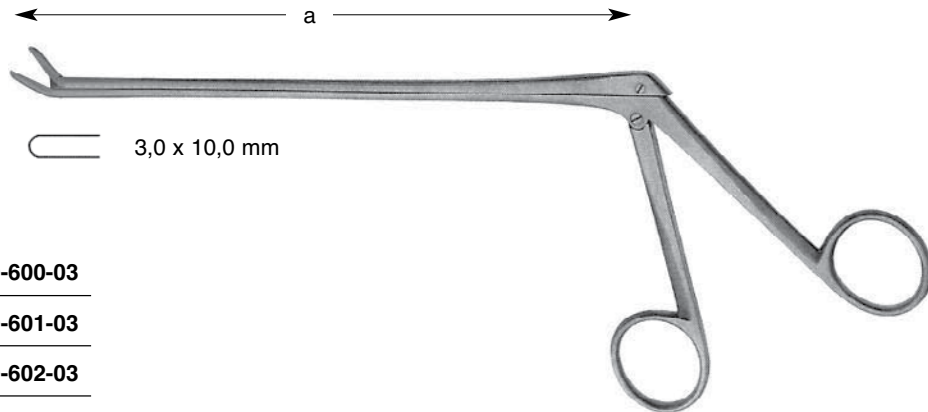

a = 130 mm	SB 240-600-03
a = 150 mm	SB 240-601-03
a = 180 mm	SB 240-602-03
a = 230 mm	SB 240-604-03
a = 280 mm	SB 240-607-03

LOVE-GRUENWALD

curved down curva

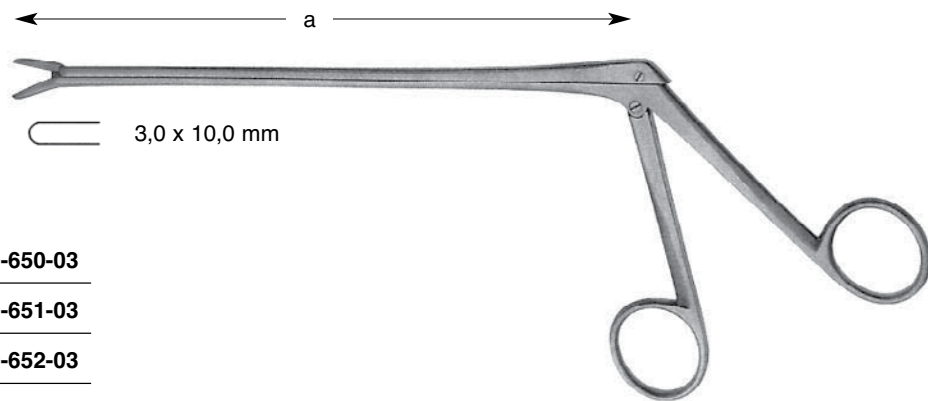

a = 130 mm	SB 240-650-03
a = 150 mm	SB 240-651-03
a = 180 mm	SB 240-652-03
a = 230 mm	SB 240-654-03
a = 280 mm	SB 240-657-03

LOVE-GRUENWALD

straight

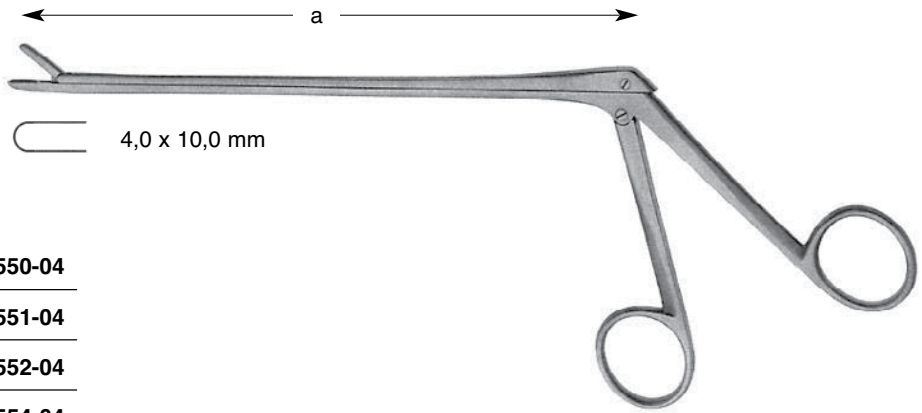

a = 130 mm	SB 240-550-04
a = 150 mm	SB 240-551-04
a = 180 mm	SB 240-552-04
a = 230 mm	SB 240-554-04
a = 280 mm	SB 240-557-04

SPURLING

curved on flat

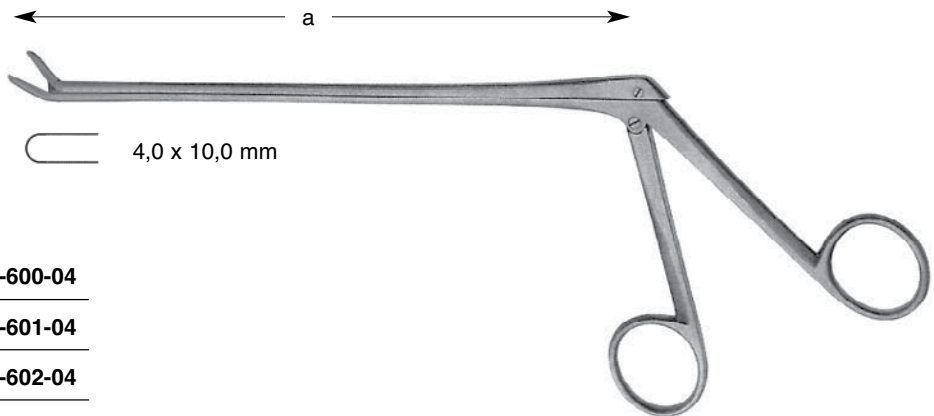

a = 130 mm	SB 240-600-04
a = 150 mm	SB 240-601-04
a = 180 mm	SB 240-602-04
a = 230 mm	SB 240-604-04
a = 280 mm	SB 240-607-04

SPURLING

curved down

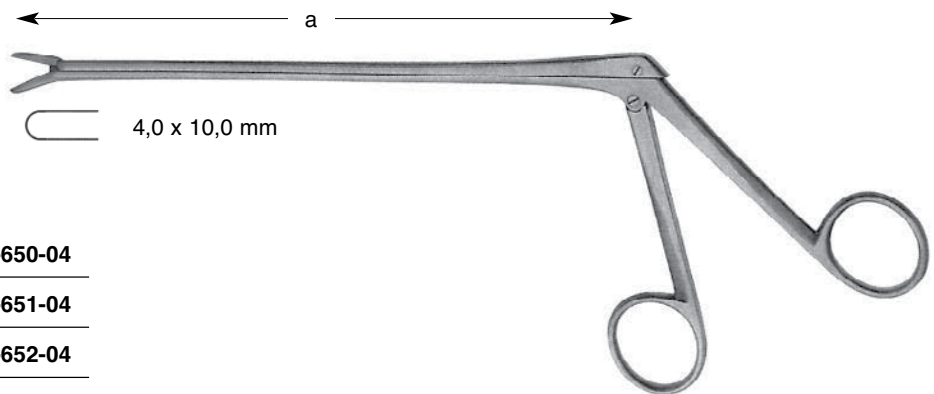

a = 130 mm	SB 240-650-04
a = 150 mm	SB 240-651-04
a = 180 mm	SB 240-652-04
a = 230 mm	SB 240-654-04
a = 280 mm	SB 240-657-04

SPURLING

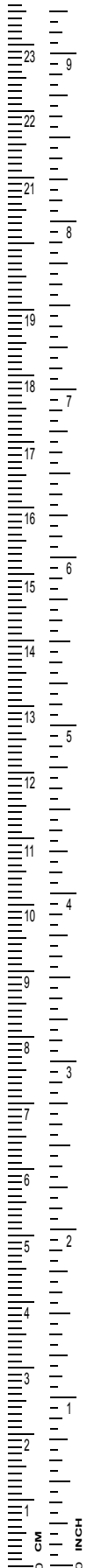





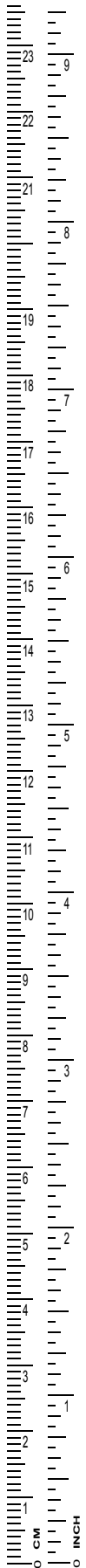

Laminectomy Rongeurs - Pinzas cortantes para Laminectomía

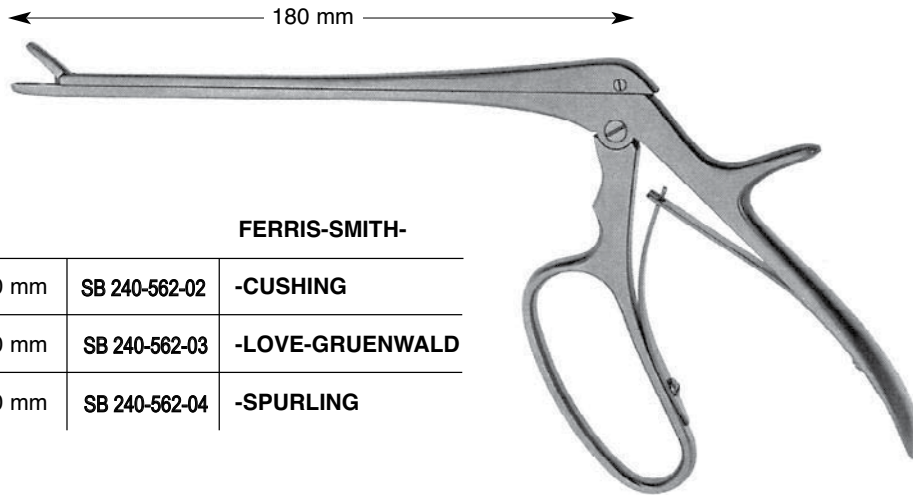

straight





FERRIS-SMITH-

	2,0 x 10,0 mm	SB 240-562-02	-CUSHING
	3,0 x 10,0 mm	SB 240-562-03	-LOVE-GRUENWALD
	4,0 x 10,0 mm	SB 240-562-04	-SPURLING

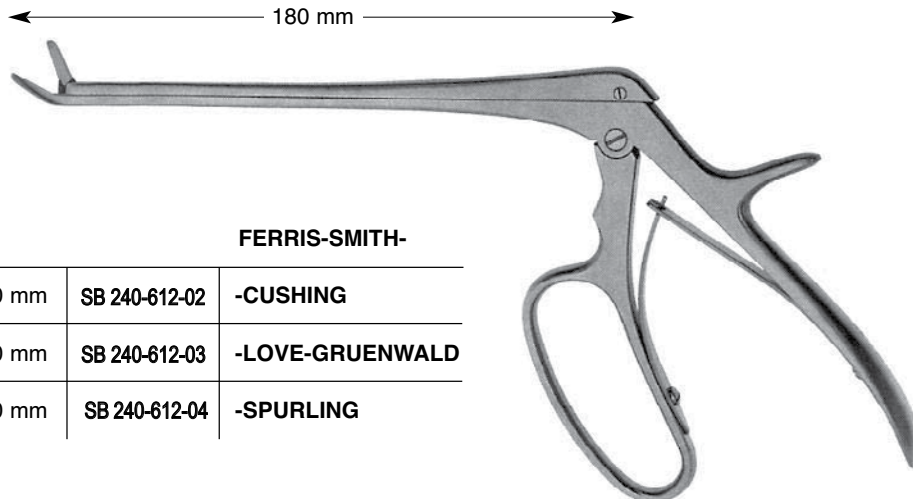
curved on flat





FERRIS-SMITH-

	2,0 x 10,0 mm	SB 240-612-02	-CUSHING
	3,0 x 10,0 mm	SB 240-612-03	-LOVE-GRUENWALD
	4,0 x 10,0 mm	SB 240-612-04	-SPURLING

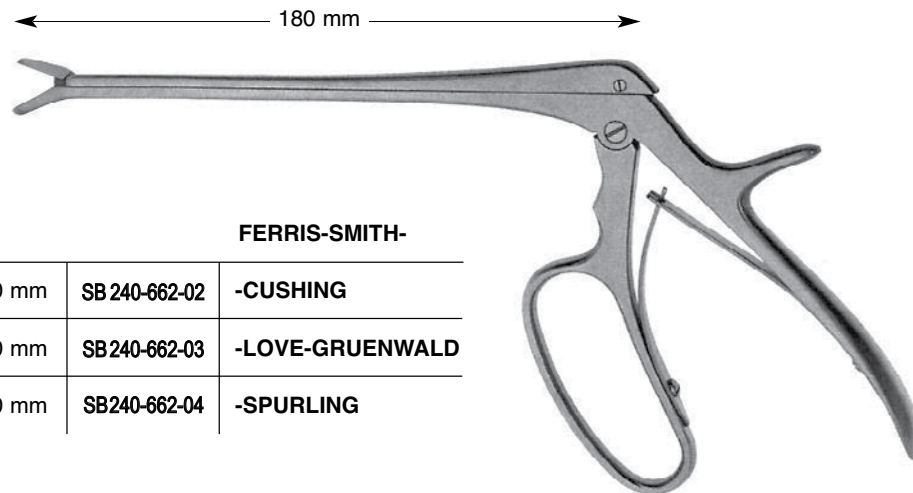
curved down



FERRIS-SMITH-

	2,0 x 10,0 mm	SB 240-662-02	-CUSHING
	3,0 x 10,0 mm	SB 240-662-03	-LOVE-GRUENWALD
	4,0 x 10,0 mm	SB 240-662-04	-SPURLING

straight

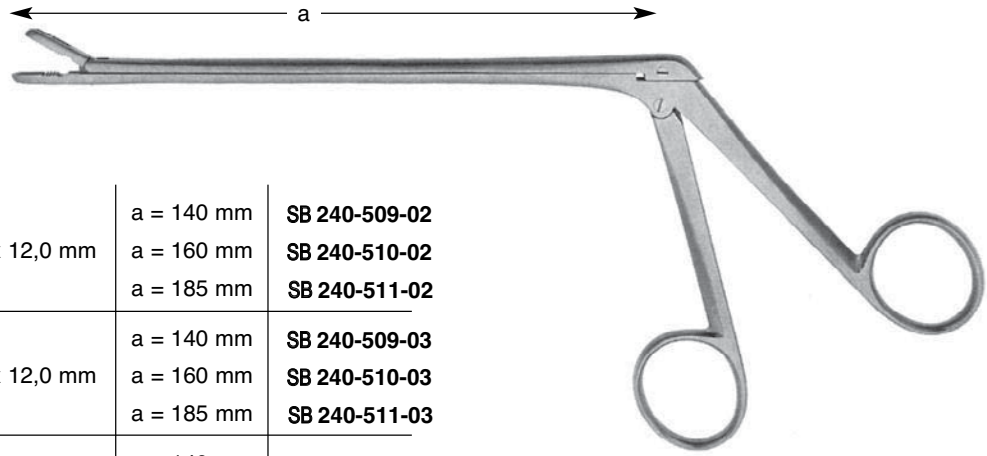

	2,0 x 12,0 mm	a = 140 mm a = 160 mm a = 185 mm	SB 240-509-02 SB 240-510-02 SB 240-511-02
	3,0 x 12,0 mm	a = 140 mm a = 160 mm a = 185 mm	SB 240-509-03 SB 240-510-03 SB 240-511-03
	4,0 x 14,0 mm	a = 140 mm a = 160 mm a = 185 mm	SB 240-509-04 SB 240-510-04 SB 240-511-04
	5,0 x 14,0 mm	a = 160 mm a = 185 mm	SB 240-510-05 SB 240-511-05
	6,0 x 16,0 mm	a = 160 mm a = 185 mm	SB 240-510-06 SB 240-511-06

CASPAR

Jaws fenestrated and serrated

curved on flat

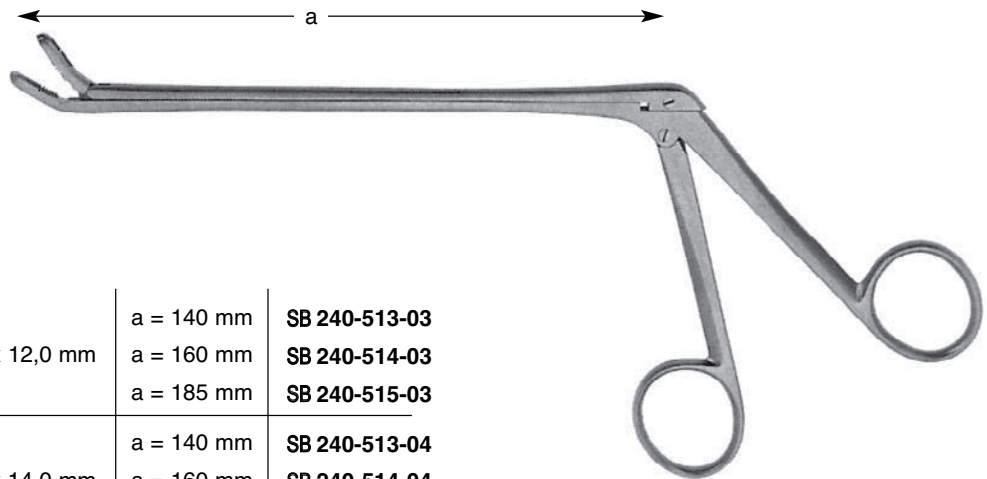

	3,0 x 12,0 mm	a = 140 mm a = 160 mm a = 185 mm	SB 240-513-03 SB 240-514-03 SB 240-515-03
	4,0 x 14,0 mm	a = 140 mm a = 160 mm a = 185 mm	SB 240-513-04 SB 240-514-04 SB 240-515-04
	5,0 x 14,0 mm	a = 160 mm a = 185 mm	SB 240-514-05 SB 240-515-05

CASPAR

Jaws fenestrated and serrated

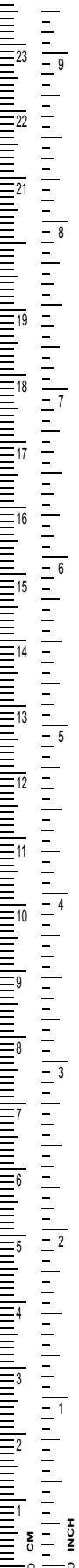



Laminectomy Rongeurs - Pinzas cortantes para Laminectomía

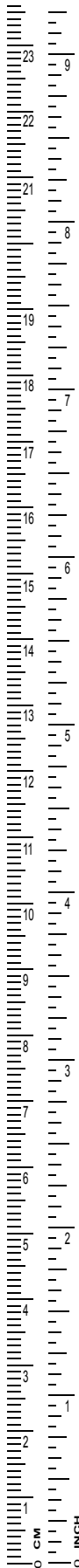

curved down

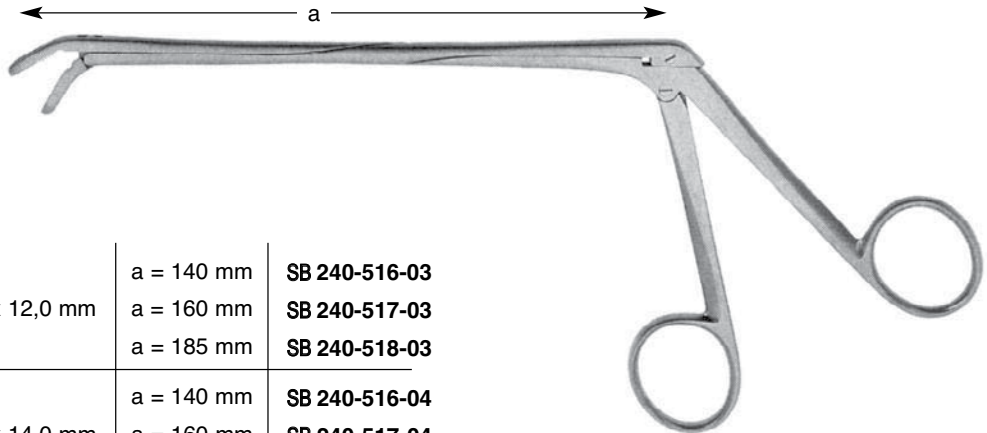

	3,0 x 12,0 mm	a = 140 mm	SB 240-516-03
		a = 160 mm	SB 240-517-03
		a = 185 mm	SB 240-518-03
	4,0 x 14,0 mm	a = 140 mm	SB 240-516-04
		a = 160 mm	SB 240-517-04
		a = 185 mm	SB 240-518-04

CASPAR

Jaws fenestrated and serrated

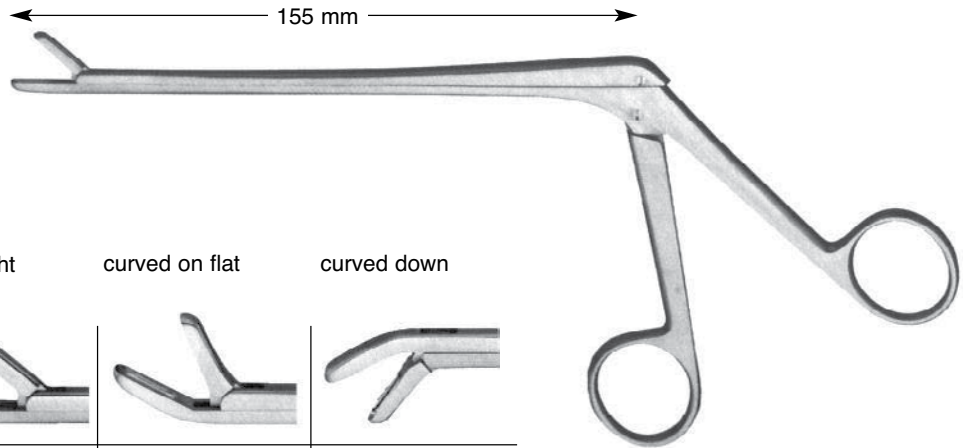

	straight	curved on flat	curved down	
 2 mm				SB 240-670-02 SB 240-673-02 SB 240-671-02
 3 mm				SB 240-670-03 SB 240-673-03 SB 240-671-03
 4 mm				SB 240-670-04 SB 240-673-04 SB 240-671-04
 5 mm				SB 240-670-05 SB 240-673-05 SB 240-671-05

CASPAR



Strategic Business Holdings, Inc.

...Quality Products, Superior Customer Service, & Support

Main +1 (800) 303-3050 Fax +1 (949) 600-8874 9620 Research Drive, Irvine - CA 92618 USA info@sbhsurgical.com www.sbhsurgical.com

Copyright © SBH ©. 2020- All rights reserved.